



888-680-4466 • ShopBotTools.com

Desktop Series Quick Start Guide



Table of Contents

Desktop Tools Safety and Precautions	5
What's in the Crate?	7
ShopBot Desktop Overview (Model DT MAX 36" x 24" Shown)	9
Uncrating	10
Assemble Parts	10
Tool Orientation and Direction of Axes	11
Video Demonstration	12
Software and Computer Configuration	13
Computer Recommendations	14
Computer Configuration	14
Installing ShopBot 3 Control Software and VCarve Pro Software	20
Software Overview	21
Plug in Pendant and Connect Power	22
Launch Software	23
Set up Home Position and Square the Machine	25
Zero the X- and Y-axes	27
Tool Movement	28
The Position Window	28
The Keypad	29
Installing a Bit	29
Zero the Z-Axis	31
Move to Home Position – Keypad Shortcut	35
Spindle Warm-up Routine	35
Desktop Spindle RPM Settings	36
Trim the Deck	37
Switch to ShopBot FULL	39

Surfacing the Deck	39
VCarve Pro	41
Maintenance	42
Transportation	42
Resources	43
ShopBot Tutorials & Videos	43
ShopBot Training Classes	43
CAD/CAM Software Packages	43
Tooling, Materials, and more...	43
ShopBot Forum	43
Technical Support	43

Desktop Tools Safety and Precautions

WARNING! Read all safety warnings, instructions, illustrations and specifications provided with this power tool. Failure to follow all instructions listed below may result in electric shock, fire, and/or serious injury. Save all warnings and instructions for future reference. Refer to the General Power Tool Safety Warnings document sent with the User's Guide.



Learn and understand safe use of the machine. Do not allow untrained individuals to operate the machine without supervision. Be aware of the location of the Emergency Stop switches at all times.



Eye and ear protection **MUST** be worn by the machine operator as well as any bystanders or observers. Flying sawdust, material chips, and other debris can cause serious eye injury.



Wear closed-toe shoes at all times.



Make sure that your material is properly secured before cutting, and be aware of any small parts that may come loose after being cut. If a small part catches the edge of a spinning bit, it can be thrown forcefully in any direction, causing injury or damage.



Never place your hands on the rails of the ShopBot. Be aware that the machine may move unexpectedly in any direction, which can cause serious injury if your hands are in the path of movement.



Never wear gloves while operating the machine. As with any power tool, a glove can get caught in moving or spinning parts and pull your hand into the machinery.



Never leave a machine running and unattended. Understand that a spinning tool generates friction and heat, creating a risk of fire. This risk is minimized by using correct chip load, using sharp bits, and by always double-checking your files before cutting. Be prepared to pause or stop the cut if something seems incorrect or unsafe.



Keep a working fire extinguisher within reach of the machine, for the reasons listed above.

Desktop Safety and Precautions (cont'd)

Limitations on ambient conditions – This tool is intended for indoor use; Do not run the tool outside or in wet weather.

The tool is intended to be used with wood, plastic, or non-ferrous materials. It is not intended for use with ferrous materials.

Transportation - This tool can be transported by two people by grabbing from the bottom front and rear locations.



Front Lifting Points
(along bottom of tool)

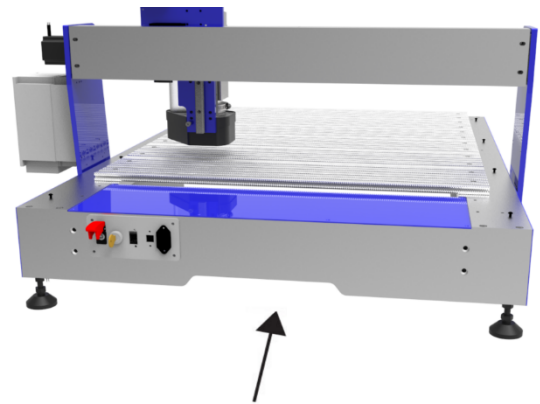

Rear Lifting Points
(along bottom of tool)



What's in the Crate?

Desktop Tools

Desktop MAX model shown above with spindle and Variable Frequency Drive (VFD) speed controller.

Manilla Envelope, which includes:



- Desktop Quick Start Guide
- Desktop Enclosure Document (if applicable)
- Accessory Documents (if applicable)
- Thumb Drive with Software



Hold Down Hardware



Z-Zero Assembly



Collet Wrenches



Pendant



Power Cord



USB Cable



1/4" & 1/2" Spindle Collet Sets

MAX ATC includes 6 - 1/4" Spindle Collets NO 1/2"

ShopBot Desktop Overview (Model DT MAX 36" x 24" Shown)

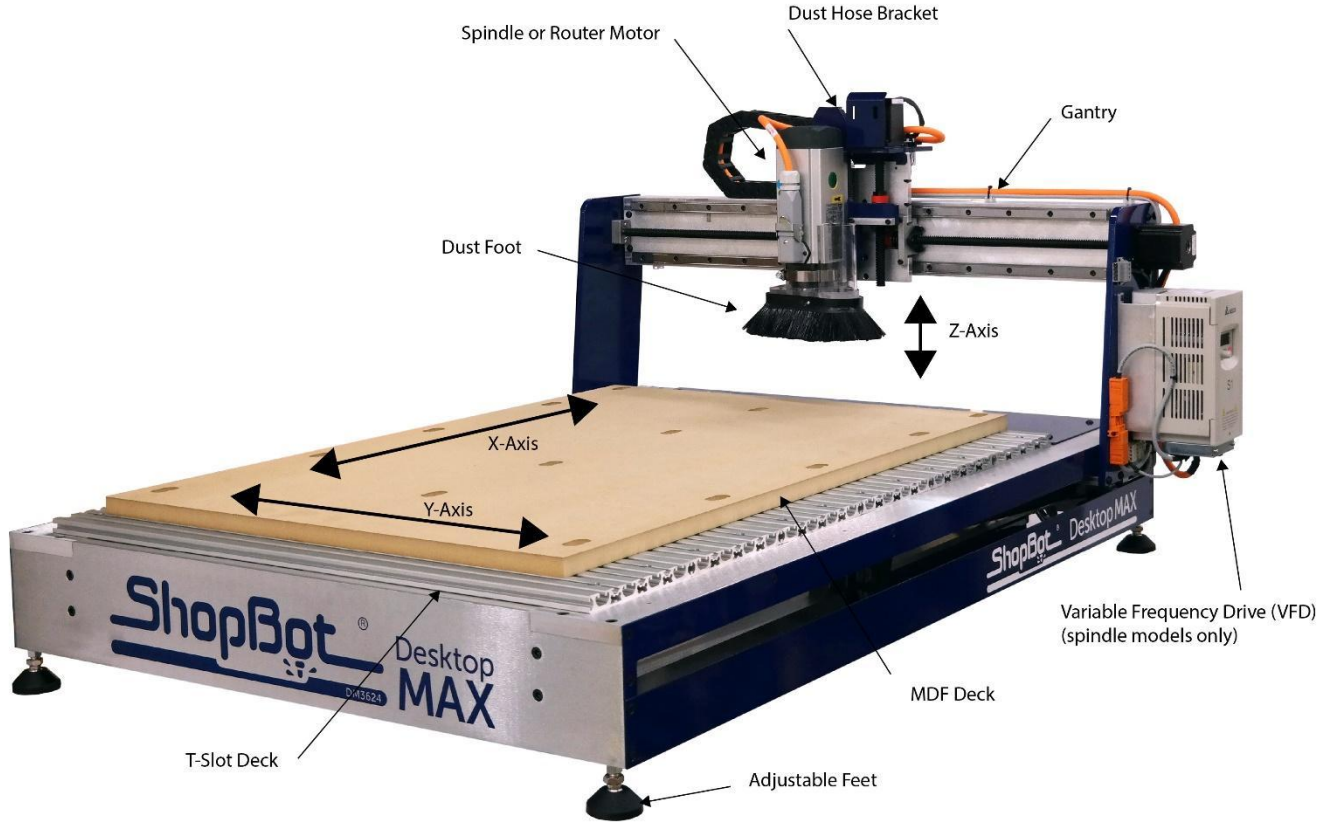

Rear Cable Connections and Power Switch

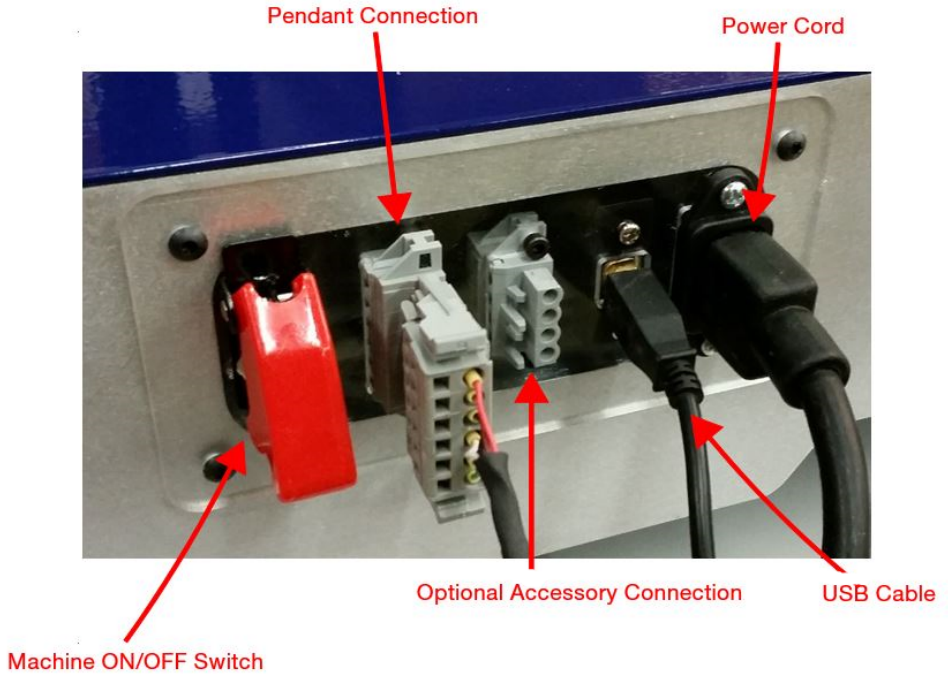

Uncrating



The ShopBot Desktop comes securely crated for shipping.

Use a claw hammer to remove each of the four metal clips.

Use caution, clips are under tension and may spring during removal.

Remove all accessories packed with the Desktop.

Remove packing materials and sides of crate using a #2 phillips screwdriver and cordless drill.

Lift Desktop onto a sturdy table or bench.

CAUTION!!

The ShopBot Desktop is a substantial tool and depending on accessories, it can weigh from 150 to 190 lbs. Have AT LEAST one additional person help lift the tool.



Assemble Parts

Adjust leveling feet with 5/8" wrench so the tool doesn't rock - then use a 9/16" wrench and nuts to lock the leveling feet into position.

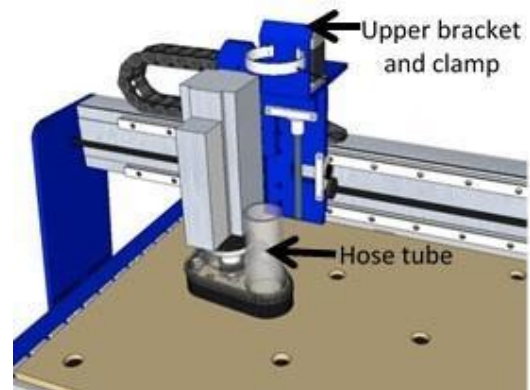

If the Desktop is equipped with a dust collector, slide the supplied hose over the vertical hose tube and attach hose to the upper bracket with hose clamp.

Note: The bottom of the hose should not be clamped so it can freely slide up and down on the tube during operation.

Refer to Desktop Dust Collection Setup Manual in the Desktop section of ShopBot Docs at www.shopbottools.com if you are planning on using dust collection.

Refer to the Mini Enclosure document to install the enclosure if applicable.

Tool Orientation and Direction of Axes

The pictures below show the axis orientation for the ShopBot Desktop 24" x 18" and the ShopBot Desktop MAX 36" x 24."

Normally, the 0, 0, 0 point is located at the intersection of the three axes as shown, and the "front" side is noted.

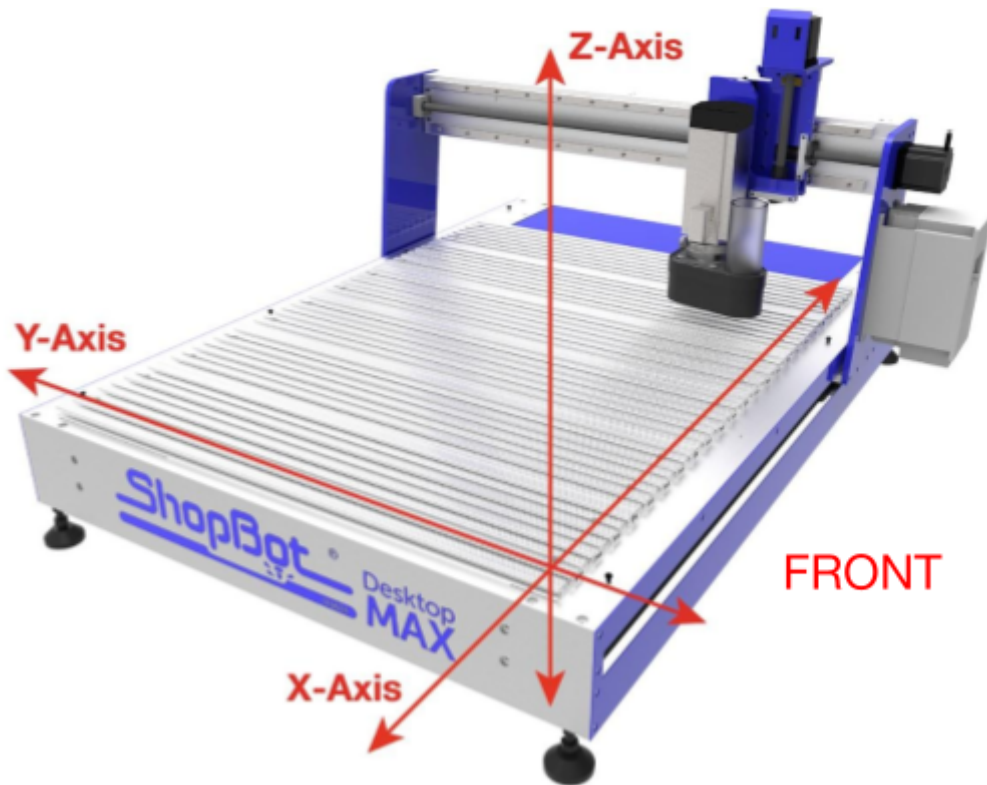
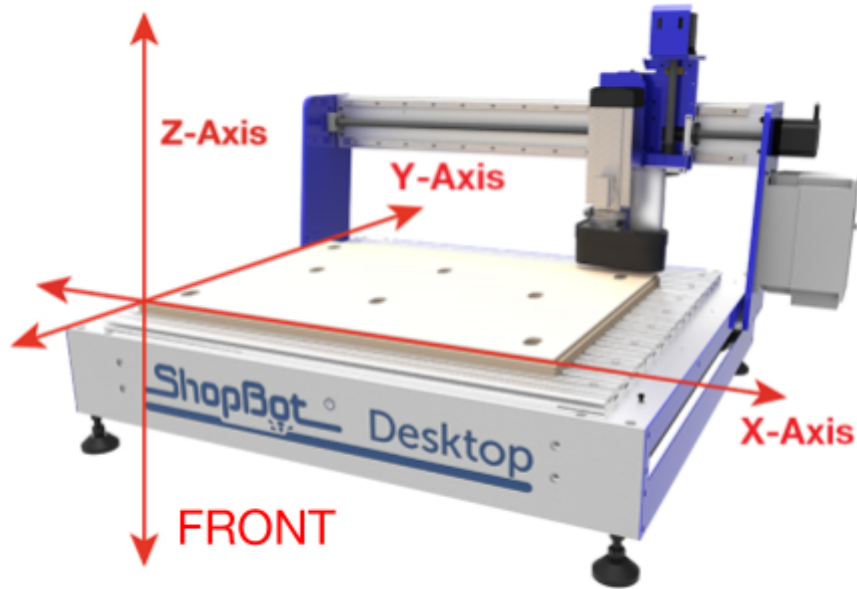

Video Demonstration

Accompanying documentation and videos can be found throughout ShopBot media. Below are links to the Desktop Quick Start Series videos. These videos and links to the ShopBot YouTube channel can be found on the Documentation page of the ShopBot Website, under the Desktop/Desktop MAX heading.

ShopBot Desktop Quick Start Videos and Tutorials:

Playlist for Desktop/MAX Setup Videos (tools shipped from Aug 2017 - current)

<https://www.youtube.com/playlist?list=PLf632tVju0dFAcVlv0Z8DrLiqm9Q0V-zC>

What's in the Crate?

<https://youtu.be/LG7ZlhAf1xg>

Installing Windows and Setting up Control Computer

<https://www.shopbottools.com/support/faq/62>

Powering up and Connecting

<https://youtu.be/f5TAIzHJTE>

Beginning Cuts and Operations

https://youtu.be/vscFI13_tOE

Playlist for Desktop Quick Start Videos (tools shipped July 2017 - earlier)

<https://www.youtube.com/playlist?list=PLf632tVju0dHQph6LOtw0HHpaTiaNMpKn>

Software and Computer Configuration

Introduction

The PC running ShopBot 3 will require special setup to prevent normal Windows and background processes from interfering with tool communication and operation. All new PCs will require these changes to their out-of-the-box state in order to optimize performance.

It is highly recommended that you exclusively run the ShopBot software from a dedicated PC. If the PC running your tool is managed by an IT department or other group, we also advise a clean install of Windows **without** any management software or settings. This will ensure that the computer is at minimal usage.

Refer to the previous page for links to videos on how to configure your computer with Windows.

ShopBot tools are shipped with three software programs that can program, edit, and run part files. This section covers the configuration of your Windows computer, installation of all software and provides a basic overview of the ShopBot control software. Additional information and training can be found in the control software “Help” menu as well as ShopBottools.com and Vectric.com.

The following software will be installed during this section:

ShopBot 3: Control software used to operate the ShopBot tool and run part files.

ShopBot Editor: Enhanced text editing software used to view and edit ShopBot part files.

VCarve Pro – ShopBot Edition: CAD/CAM software used to create and edit designs, and assign tool paths to create part files.



Computer Recommendations

A PC running Windows XP to the current version of Windows is required. The equivalent of a dual core or higher processor, and a minimum of 4GB RAM (8GB preferred) is recommended.

A graphics display of 1024 x 768 will provide a good display, although a higher resolution may be preferable.

Computer Configuration

Important: Some programs and features will interrupt the proper installation of ShopBot 3 control software. To ensure trouble free installation and operation, ShopBot recommends performing the following actions before installation.

- _____ 1. Install the software using an administrative account.
- _____ 2. Set User Account Control (UAC, not applicable to Windows XP) to “Never Notify.”
- _____ 3. Set power options
- _____ 4. Windows update settings/Disable network connection.
- _____ 5. Disable background tasks.
- _____ 6. Make sure the USB cable from the ShopBot is not plugged in.

Before continuing, open the Windows Task Manager and click on the “Performance” tab. Below is an example of a good setup. There are no processes greatly affecting CPU usage and 4GB RAM is available.

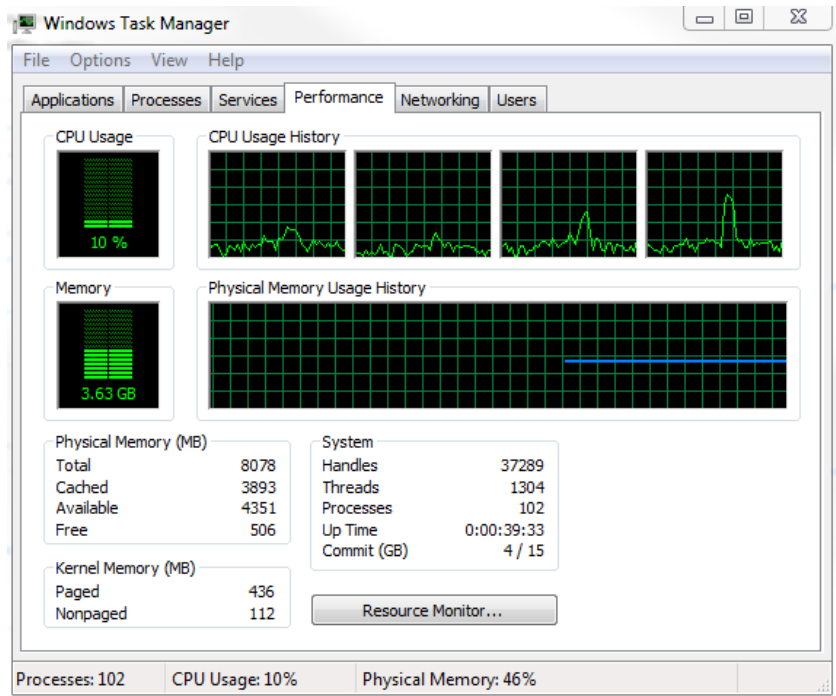

1. Install the software using an administrative account

When it comes time to install SB3 and VCarve Pro (later steps) make sure you are using an administrative account.

2. Set User Account Control (UAC, not applicable to Windows XP) to “Never Notify.”

The first process to change is User Account Control. This can be found by performing a search from the Start Menu in Windows 7 & 10, or by swiping in from the right edge of the screen and selecting the “Search” icon in Windows 8. Then, type “User Account Control” or “UAC” into the search box and press Enter. This will bring up the User Account Control Settings window, containing a slider. You should ensure that this is set to “Never Notify”, as it will prevent popups from interrupting software.

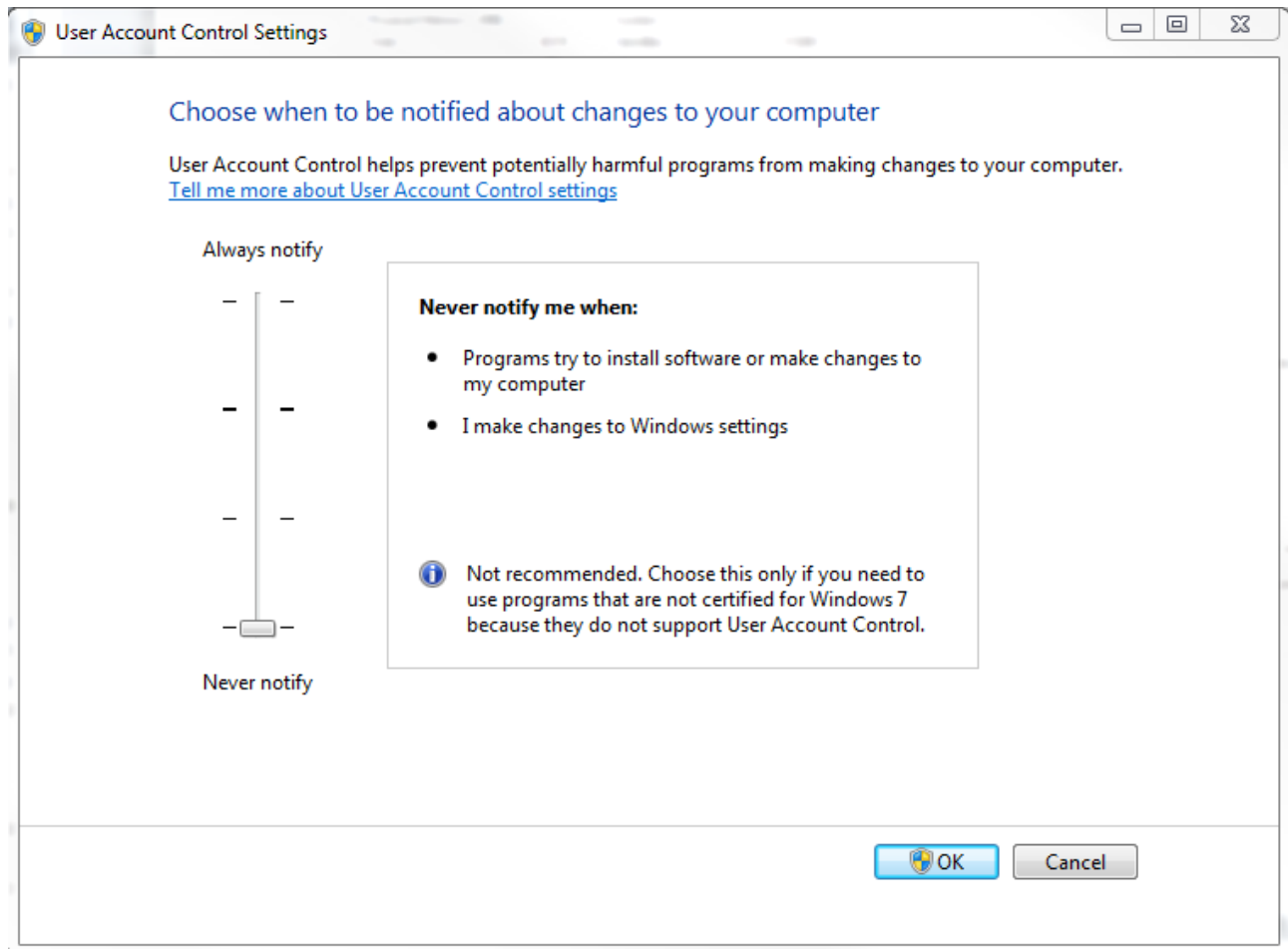

This is what the UAC settings window should look like. Note the slider is set to “Never Notify”.

3. Set power options

Next, you will want to change the Power Options. To begin, open the Start Menu (for Windows 7 & 10, click “Start”; for Windows 8, swipe from the right). Type “Power Options” in the search box and press Enter. This will bring up a menu in which you are asked to “Select a power plan”(see image below, left side).

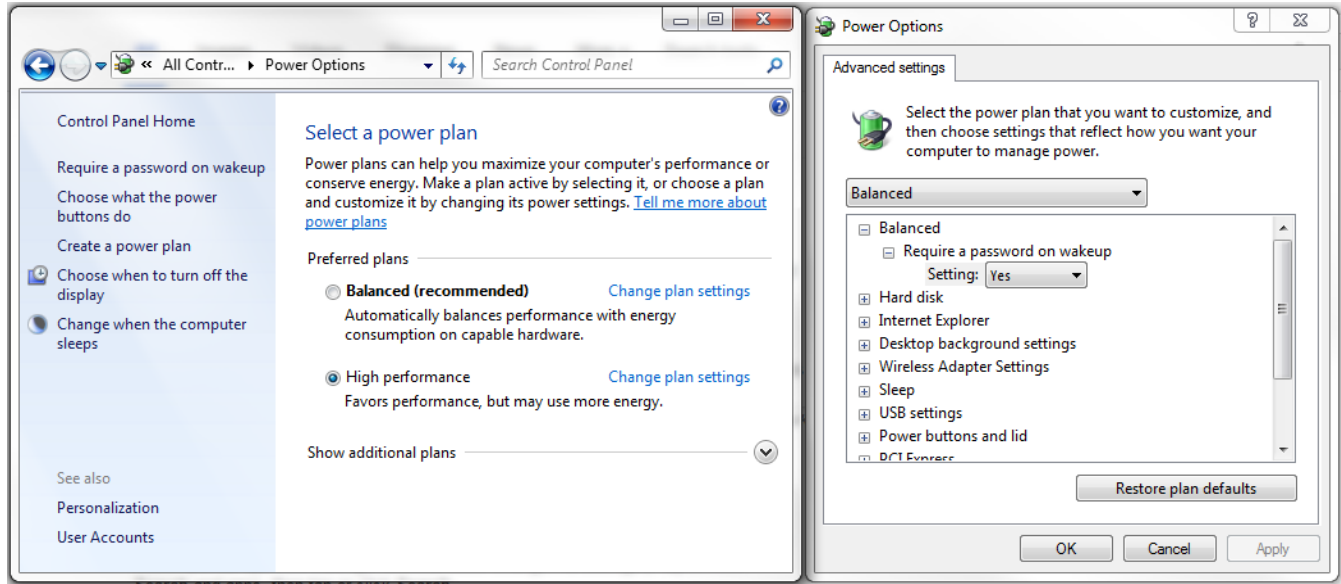

Under “preferred plans”, you will see multiple options. Click “Change plan settings” to the right of one of these options to bring up the Power Options menu (see image above, right side). Expand the “Sleep” option by clicking the plus sign to its left, and set the values to the following:

Sleep after: **Never**

Hibernate after: **Never**

Allow hybrid sleep: **Off**

Next, expand the “USB Settings” option and set the values to the following:

USB selective suspend: **Disabled**

Click the “OK” button to save these settings.

4. Windows update settings/Disable network connection.

To disable Windows Updates, open the Start Menu* (for Windows 7, click “Start”; for Windows 8, swipe from the right). Type “Windows Update” in the search box and press Enter. This will bring up the Windows Update settings. In the left-hand pane, select “Change settings”. Under “Important updates”, select “Never check for updates (not recommended)” and click “OK”.

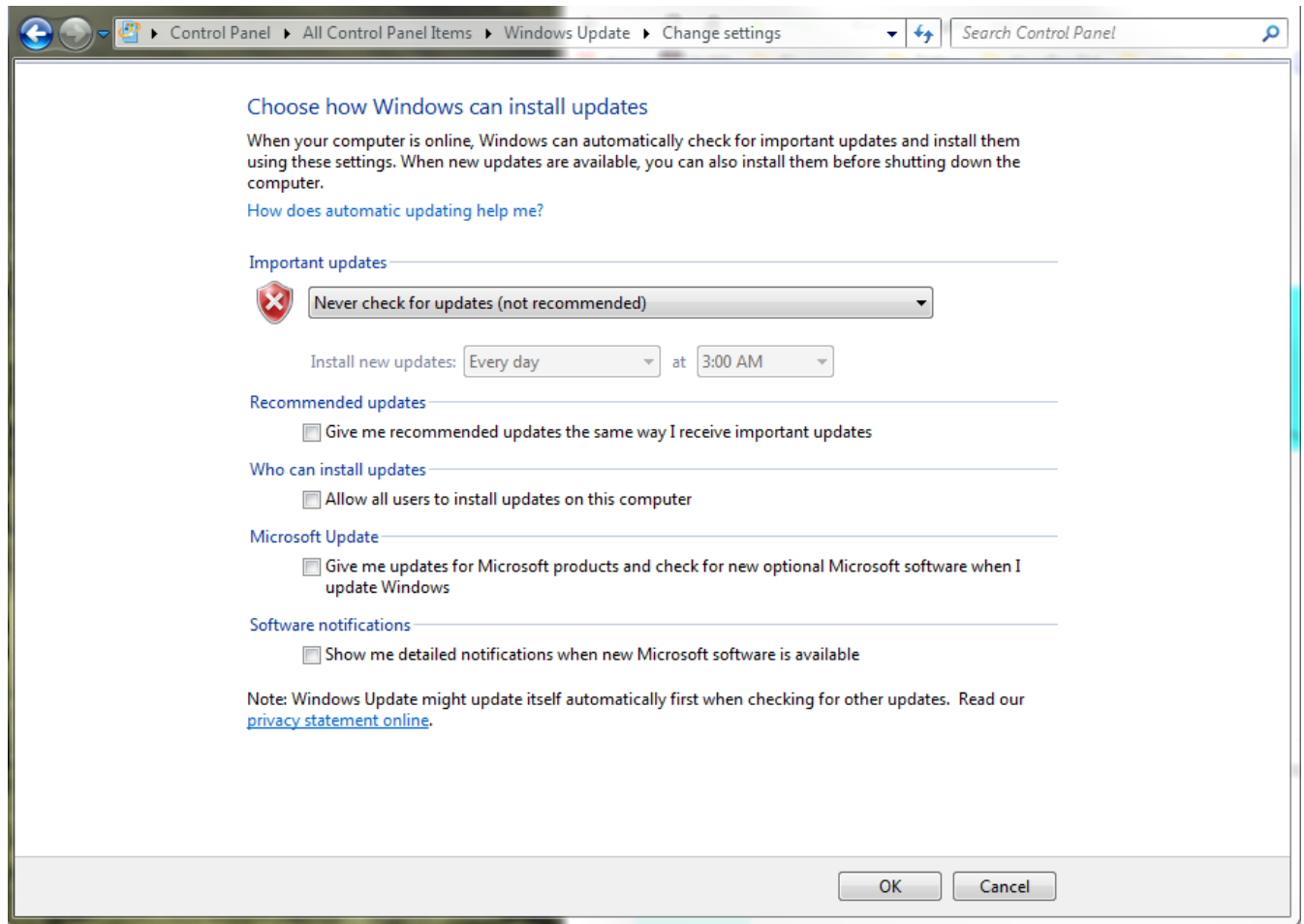

Set Windows Updates settings to “Never check for updates”. This will disable automatic checks and allow you to manually update at your convenience.

***NOTE: Windows 10 does not have this same functionality. To disable updates, you can place the machine into Airplane Mode or disable the computer's Wireless Adapter.**

5. Disable background tasks.

Next, you should disable any conflicting background tasks. To access the Task Manager, press “Ctrl+Alt+Delete” and select “Task Manager”.

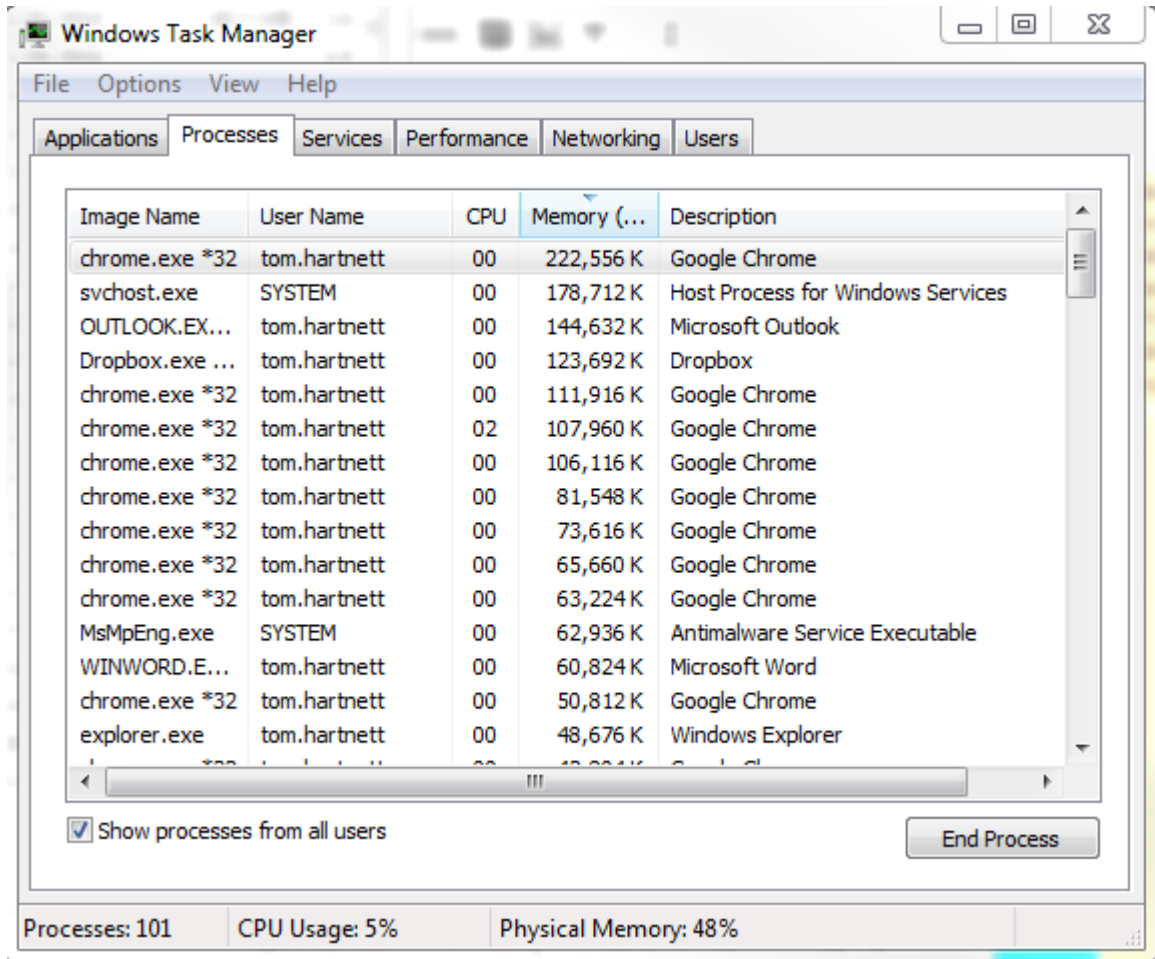

With the Task Manager open, click on the “Processes” tab, which will bring up a list. Click on the “Memory” column header to organize the list by physical memory used. Make a list of any programs that are utilizing excess memory and are unnecessary to the function of ShopBot 3. Then, sort the list by “CPU” column and do the same.

Next, we will uninstall unnecessary programs. To access the Uninstall window, search from your Start menu, type in “Uninstall”, and press Enter. Then select “Programs and Features” (you can also navigate directly to **Control Panel > Programs and Features > Uninstall or change a program**) and sort the results by name or date installed.

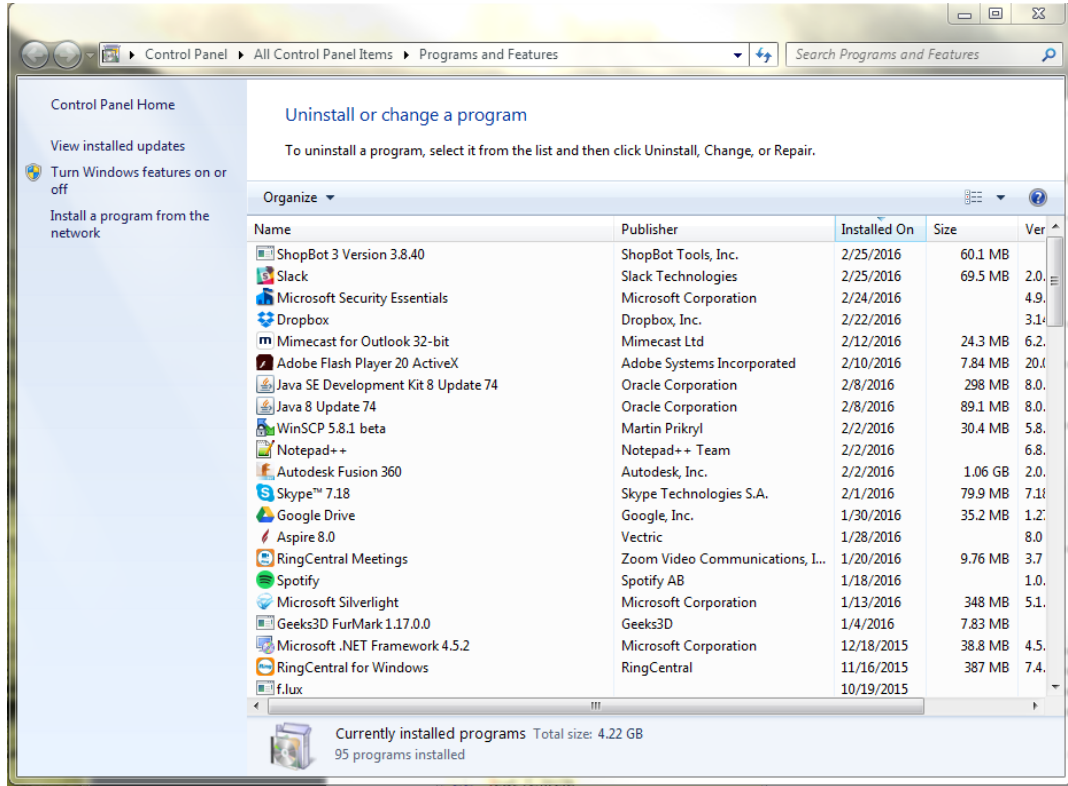

Using the list created in the previous step, address any programs that are not essential to ShopBot 3 operation. Most specifically, you will want to remove or disable any programs that perform scans or update automatically in the background.

Be sure to uninstall any third party antivirus, firewalls, anti-spyware, iTunes, file sharing, and game services. If an antivirus software is needed, Windows Security Essentials (comes with Windows 7 & 8) or Windows Defender (Windows 10) should not affect the communication of the tool.

6. Make sure the USB cable from the ShopBot is not plugged in.

Having the USB cable plugged into the tool while installing the SB3 software can cause issues with the installation, so keep the cable unplugged until all installation is done.

Conclusion

Following the preceding steps are meant for those running a ShopBot on a computer for the first time. Note that the procedure for disabling tasks and programs can vary depending on the version of Windows and software being run. It is recommended that you consult with your operating system guide, software documentation, or systems administrator before making any major changes to software. If you are unable to find a specific setting or process mentioned anywhere in this guide, a search on the TalkShopBot forums or Google can generally give the results you need.

Installing ShopBot 3 Control Software and VCarve Pro Software

Note: Make sure USB cable from the control box and VFD are **not** plugged into the computer.

ShopBot 3 Control Software: The SB3 Control Software is located on the blue thumb drive, which should be hooked to one of the rings in your ShopBot Handbook.

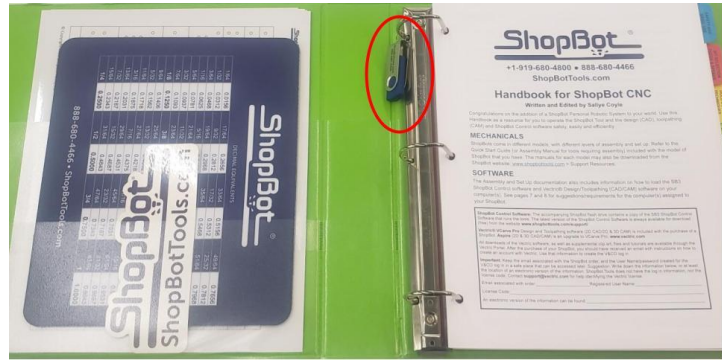

Open the drive, and then open the “ShopBot CONTROL Software” folder. Right click the Setup file and click “Run as administrator”, then follow the instructions.

Note: Once the SB3 software is installed, you will need to right click the SB3 icon and choose “Run as administrator” the first time you run it to complete the installation.

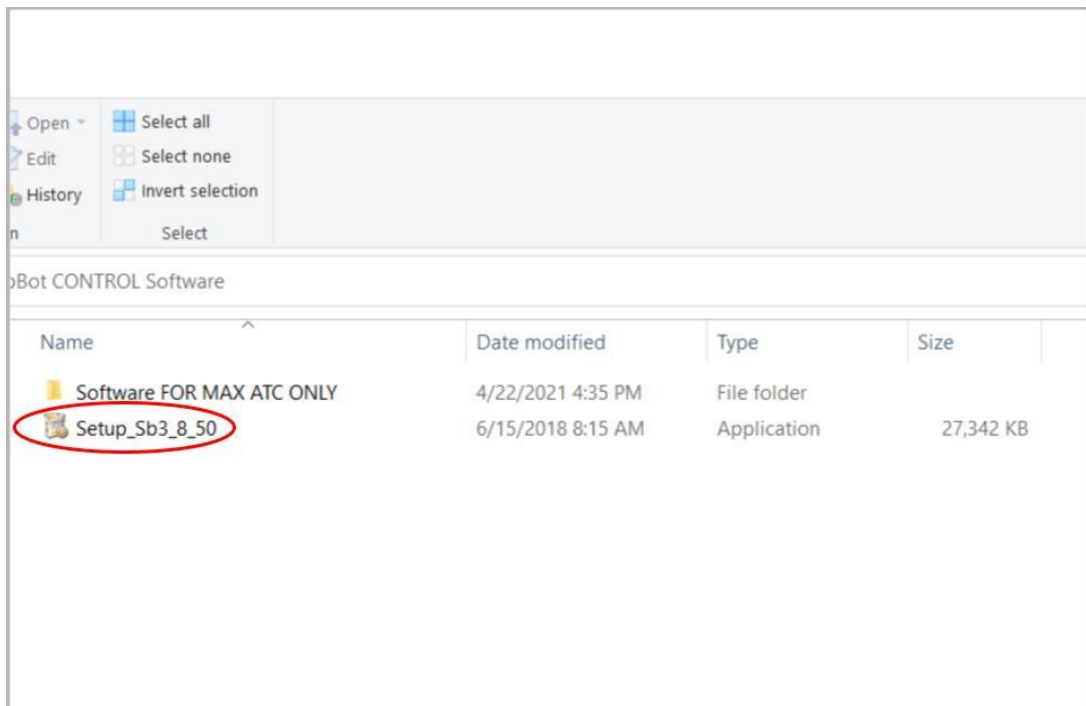

VCarve Pro Software: ShopBot customers are now able to register their Vectric software license directly and receive a V&Co. portal account.

Note: Any ShopBot customer wishing to later **update** or **upgrade** their software must do so via their Vectric customer portal (not through ShopBot).

You should have received an email after purchasing the ShopBot tool with the link to the Vectric portal and your registered username and license number. The software should be registered by the individual who will control the license and will be tied to that single contact person and the email address used to register. Any change in contact or registered email address can only be done by emailing support@vectric.com.

Note: Reach out to ShopBot if you did not receive an email with your Login info

After registering your license, you can log into your Vectric V&Co. portal again by:

1. Go to the URL: <https://portal.vectric.com/>
2. Enter the email address you used to register the software and the password you picked

How can I download my software, clipart and license details?

Your V&Co. account will always hold your license information, and the latest version of software (including patch upgrades) you are entitled to, so you don't have to worry about losing your details or re-installing your software if you get a new computer, but you will need to use the credentials including the email address you used to register.

1. Log into your V&Co. portal account (see above)
2. Scroll down to the section **'your latest software, clipart and licenses and click 'view downloads'**
3. Click **'view license and download'** for the required product
4. From the 'downloads' section click **'download'** for the item you wish to download and install

Software Overview

All programs included with the ShopBot are now installed. The icons below represent how they will appear on the computer desktop.



Plug in Pendant and Connect Power

Pendant Connection



Plug the pendant into the connector on the tool located in the rear (on Desktop tools) or right side (Desktop MAX tools).

The pendant has three functions:

Machine ON/OFF Switch

- 1) A keyed interlock switch to cut power to the router or spindle. The machine can still be moved with the interlock turned off, but the cutting head will not be able to spin.
- 2) A start/stop button. For non-emergencies, simply hit the spacebar on the computer keyboard or the start/stop button on the pendant. This will pause the tool while maintaining XYZ coordinates, allowing the cut file to resume without starting over.
- 3) An emergency stop switch. Pressing the emergency stop is the same as turning off the main power switch. The tool will immediately stop moving and the cutter will turn off. Machine position WILL be lost during an emergency stop. To release the emergency stop on the pendant, turn the red button clockwise until it releases and pops up.

The presence of an emergency stop switch does not alter the need for good safety procedures while operating the ShopBot tool.

Also note that if the pendant is not plugged into the machine, the machine will not power on. If the pendant comes unplugged, the emergency stop will automatically trigger and the machine will shut down.

Spindle Interlock Stop/Start Button Emergency Stop

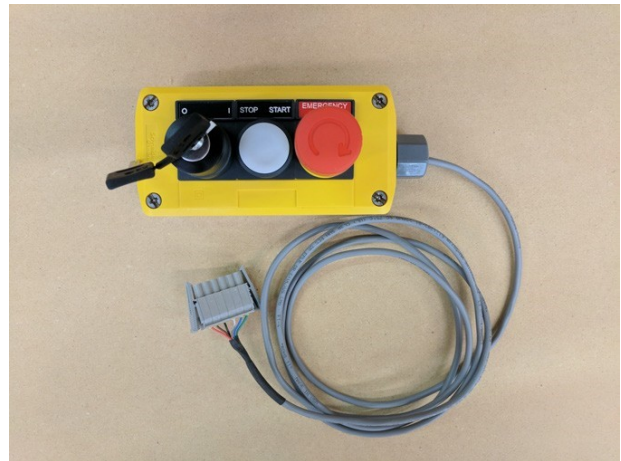

Power Cord



Install power cord into the back of the tool.

Plug the power cord into a standard 110 volt 15 amp receptacle.
(International tools 220v)

Note: Do not use a ground fault circuit interrupter. (GFCI)



USB Cable

Install USB Cable into the back side of the machine.

Connect USB cable to computer and Windows will recognize a "New Device."

Note: Ensure the port is a USB 2.0 port. It is best to use the same USB port every time the ShopBot is attached to the computer.



Launch Software

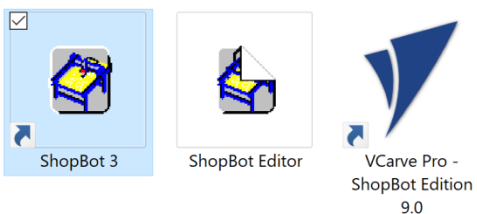

Right-click the ShopBot 3 icon and select Run as Administrator to open the machine's control program for the first time.

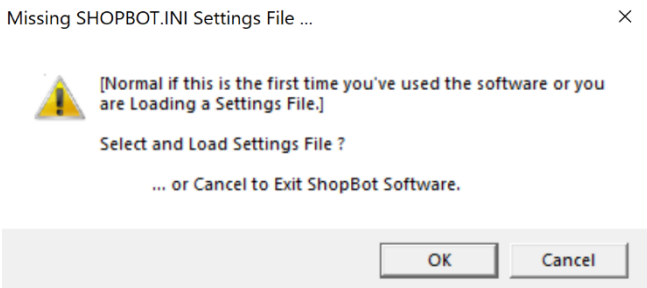

The first time the program is opened, there will not be a settings file for the machine. Click "OK" and a prompt will appear to load a settings file for the machine.

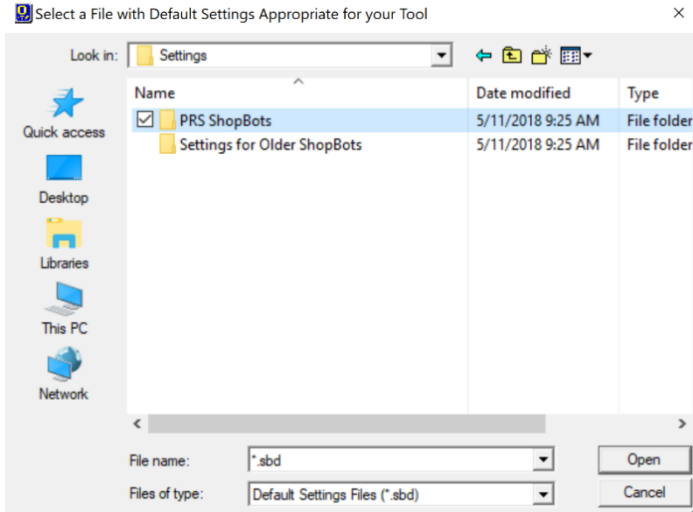

Access the PRS ShopBots folder and Open it.

Find the Desktop Settings file, “ShopBot_PRSDesktop2418.sbd” or “ShopBot_PRSDesktopMAX3624.sbd” depending on your model.

Note: If this file is not available, it can be found on the ShopBot website under the Control Software heading, or at:

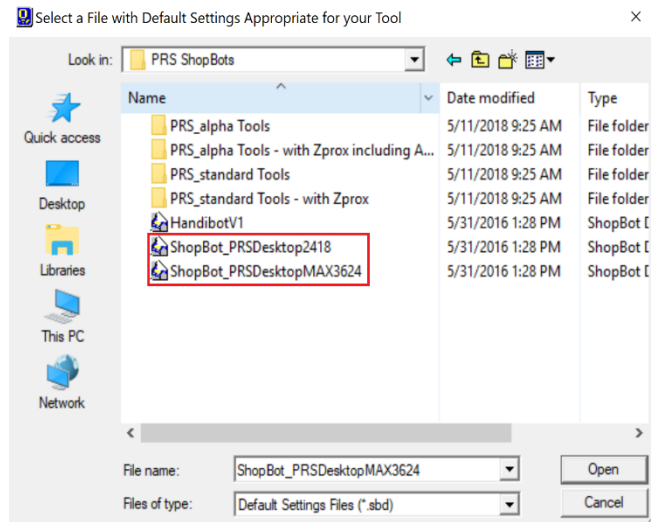

<https://support.shopbottools.com/support/control-software>

Save the file to a thumb drive for future reference

Set up Home Position and Square the Machine

The Desktop tools are somewhat unique among the ShopBot tool lineup in that they do not use the default home position indicated by the SB3 software. Upon loading the Desktop tool profile the home location should be correct. However, if it is not for any reason, the following procedure will change the home position to be at the corner of the MDF spoil board that was installed at the factory.

The second procedure will square the gantry of the machine by crashing it against the hard stops. Because the gantry is driven by one motor on each side, it is possible for the motors to come out of sync. This can happen if the machine is moved with the power off (like during shipping), or if the machine were to hit something unintended and lose position.

The squaring part of the procedure will produce a loud “grinding” sound, as the stepper motors are stalling out. This does not, however, harm the motors in any way.

In the SB3 software, click the “Cut Part” button at the bottom of the window.



A file browser window will now pop up. Navigate to C:\SBParts\

This folder can be found by going to the “Computer” file location, then open the “C:” drive or main disc found under “Devices and Drives,” there the SBParts folder should be found. The folder should look like the figure shown:

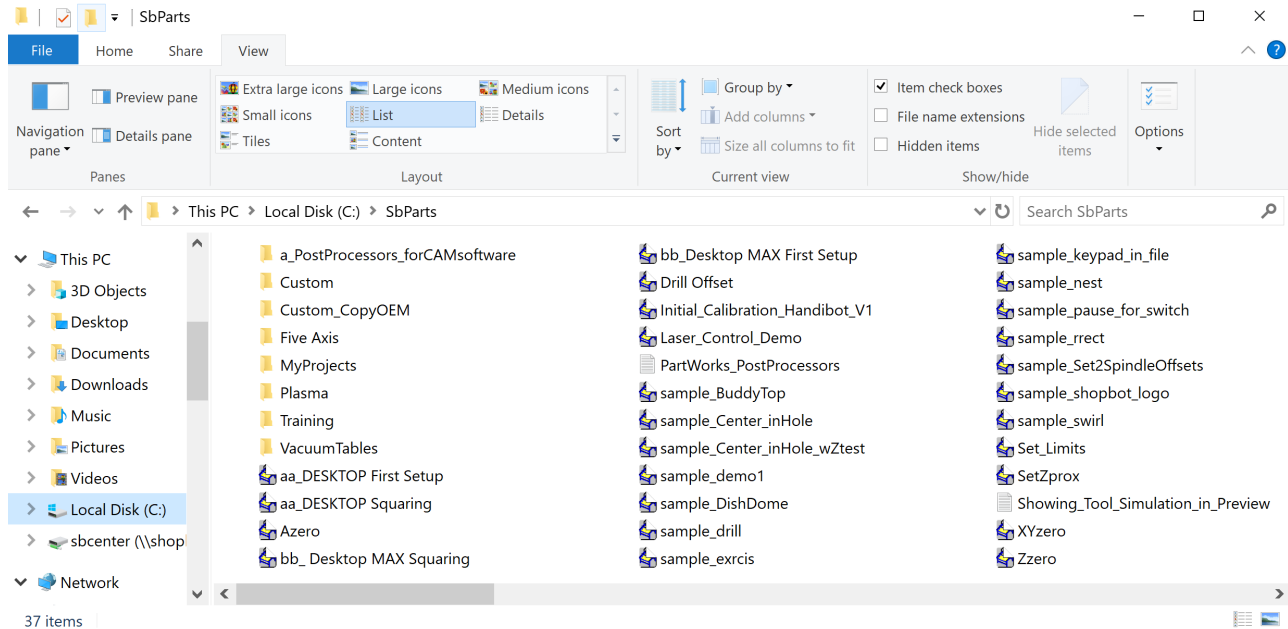

Select either the file named “aa_DESKTOP First Setup” if you have a Desktop or “bb_Desktop MAX First Setup” if you have a MAX and then click the Open button.

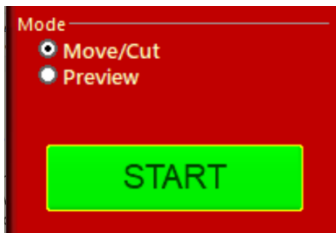

Now press the “START” button.

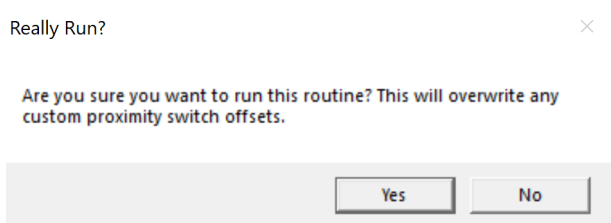

When prompted, click “Yes” to run routine. The program does not visibly do anything, but it will change your proximity switch offset variables for cutting the rabbit into your spoil board in a later step.

Press “Cut Part” again.

Locate and Open “aa_DESKTOP Squaring” or “bb_Desktop MAX Squaring” file in the SBParts folder.

Then click START to run the squaring routine.

When prompted, click “Yes” to run the routine.

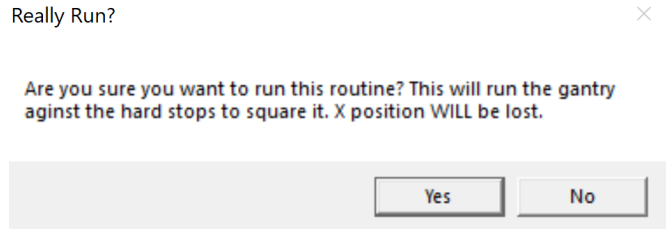

IMPORTANT! This procedure should be performed any time the machine is crashed, after the gantry is moved by hand with the power turned off, or after the machine is moved to ensure that the gantry is square. If this process is not performed, the cut program could be noticeably off.



Zero the X- and Y-axes

Note: Ensure the setup and squaring process has been run prior to performing this step!

The cutting head now needs to be in the lower left (front) corner of the deck (X=0, Y=0 position).

As an 1/8” rabbet is being cut into the spoil board around the whole edge, the 0,0 location will be 1/8” from the home corner.

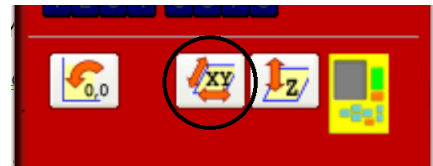

Click the white button marked with the “XY.” Or select the **[C]uts->C[3] Home XY Axes Using Prox Switches** function from the dropdown menu.

The machine will now move through an automatic routine that zeroes the X- and Y-axes to the lower left (front) corner of the machine using the proximity switches.

Once the routine finishes, the X and Y locations in the position window should now read .000 units. The physical location of the cutting head should be 1/8” in from the corner of the board, ready for the rabbet cut.

If the location is not correct, refer first to the video tutorial for steps on setting up the home location before cutting the rabbet file: “Desktop Series – Beginning Cuts and Operations” - https://youtu.be/vscF113_tOE.

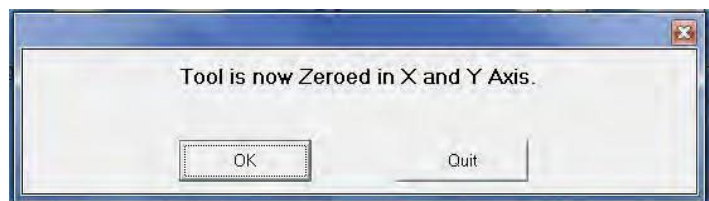

Click OK on the “Tool is now Zeroed” message.

The cutting head should now be in the front corner of the deck.

The picture to the right shows a Desktop MAX at the home position while standing at the left end of the tool.

Below is a close up picture of the cutting head at the 1/8" from the corner mark on a Desktop.

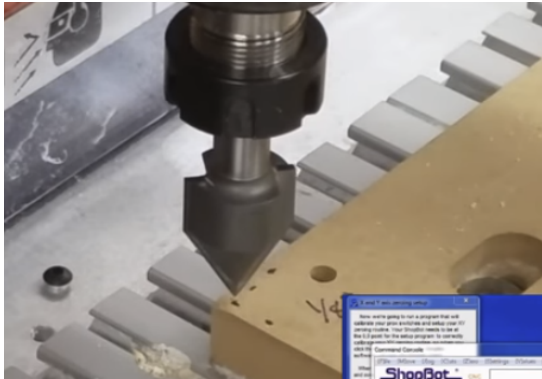

Tool Movement

The Position Window

This red panel provides essential machine information and controls. The following steps will walk through the most frequently used controls and steps to get up and running, this includes: installing a bit, zeroing the machines X-, Y-, and Z- axes, and cutting.

Click on the yellow button to bring up the “Keypad” panel.

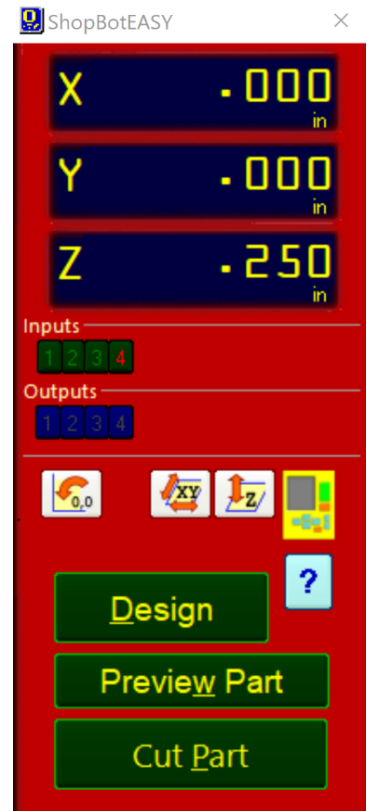

The Keypad

Note: Do not move the tool with the keypad until the “Setup Home Position and Square the Machine” step is complete.

This window allows the user to manually move the X-, Y,- and Z-axes of the machine. Click on the blue arrows to move the spindle/router and gantry.

X- and Y-axes can also be moved with the cursor buttons on the computer keyboard. Use the “Page Up” and “Page Down” buttons on the keyboard to move the Z-axis up and down.

Move the spindle to a safe Z position below the Z proximity switch and near the middle of the deck.

Click on the X in the upper right corner to close yellow Keypad.

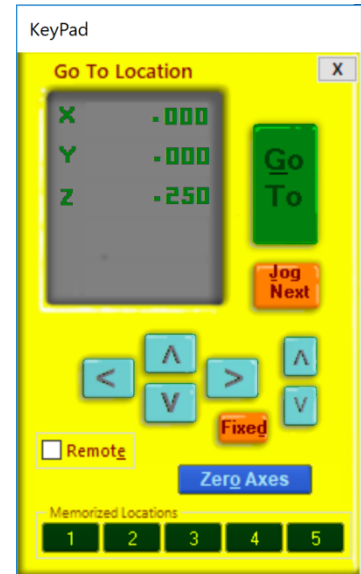

Installation - Bit





Switch Off the Spindle First

Make sure the key switch on the pendant is turned to the OFF position (counter-clockwise). This will cut the power to the spindle.

Collet and Collet Nut for the spindle.



NOTE: If you purchased a MAX ATC, refer to your Desktop MAX ATC User Manual for instructions on how to set up your collets and collet nuts in the tool holders.

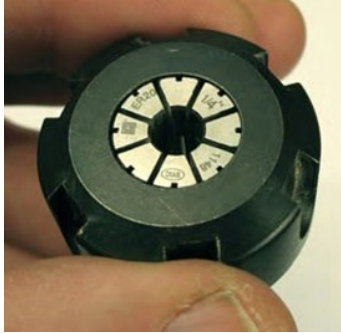

Press the spindle collet into the spindle nut and listen for the “click.” It may be necessary to press it in at a slight angle. Confirm that the collet is snapped in place by holding the nut upside-down (shown in the photo at left) and letting the collet hang freely. It should not fall out.

The first cut done is the profile rabbet cut which is done with the 1/4” diameter upcut spiral bit. Install this bit now if cutting the rabbet.

Slide the bit into the collet. Ideally, the shank of the bit should fill up at least 75% of the collet to provide sufficient gripping surface. It is okay if the shank of the bit extends above the top of the collet (maximum 3/8” of excess). Make sure that the collet grips only the shank of the bit, keeping the top edge of the flutes outside of the collet.

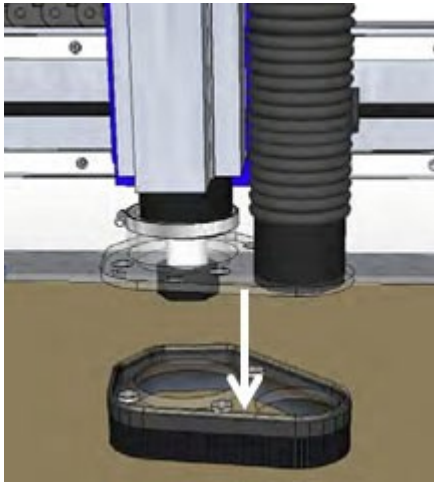
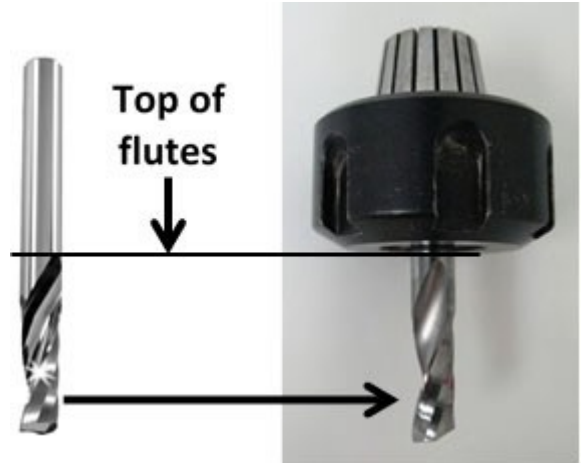

Remove bottom of dust foot by pushing it down. It is attached with magnets, which makes it easy to remove. Set dust foot out of the way.

Hold spindle to keep it from turning, and hand-thread collet nut onto spindle. It should go on very easily. If resistance is encountered, do NOT apply force. Stop and try again until it goes smoothly. Once the nut is finger-tight, reposition the bit if it has slipped.





Use the included wrenches to fully tighten the nut.

Over-tightening will make the collet difficult to remove and may damage it. Under-tightening will allow the bit to slip during operation.

Tightening the collet nut without fully installing the collet may also bind the assembly beyond recovery.

A firm one-hand squeeze is usually sufficient – a torque of approximately 59 ft-lbs.

Zero the Z-Axis

Zeroing the Z-axis requires a few more steps than zeroing the X- and Y-axes, be sure to run it a few times to ensure it is properly performed and understood.

Refer to the *Zeroing the Z-Axis* section of the “Desktop Series – Beginning Cuts and Operations” video for more information and a demonstration of the process. https://youtu.be/vscFI13_tOE.

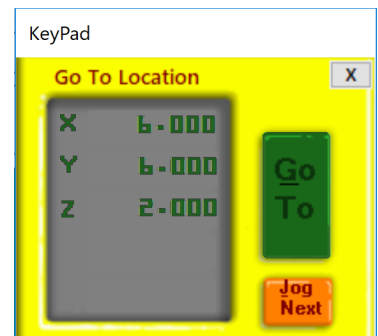

Open the yellow KeyPad and move the head towards the center of the board in the X- and Y-axis. Move the Z-axis up to around 2 inches above the table.



The picture above shows the KeyPad after moving to a convenient location for zeroing the Z-axis.

Now plug the Z-zeroing assembly into the corresponding socket found on the gantry table leg with the VFD and gantry motor.

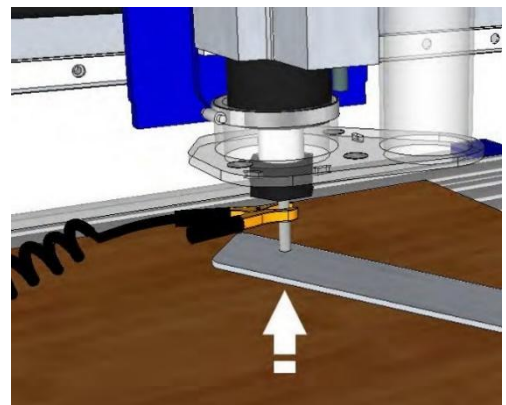

Attach the Z-zero grounding clip to the router bit (or collet nut) and touch the Z-zero plate to the bottom of the bit.

When the Z-zero plate touches the router bit, Input 1 should light up. The Input 1 light will go off when the Z plate is removed.

It is important to check this each time the grounding clip is connected to verify contact is good. If Input 1 does not light up, ensure the grounding clip is well connected and try again. To the right is a picture of Input 1 lit up.



After confirming Input 1 is behaving correctly, place the Z-zero plate on top of the spoil board beneath the router bit.

Note: Machine can be Z-zeroed to the top of the spoil board or to the top of the project material depending on how the design file is set up.

Click the white button marked “Z” shown in the image to the right.

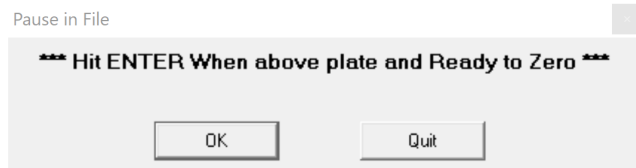
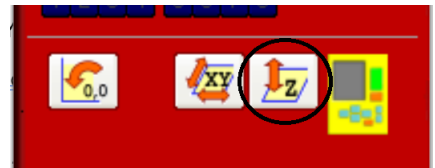

A prompt will appear, ensuring that the Z-zero plate is under the router bit. Double check the location of the Z-zero plate and click OK. An alarm will sound to signify that the tool is going to begin moving.

Hold the Z-zero plate level while the routine runs.

The cutting head will lower until the bit contacts the Z-zero plate. It will then retract and repeat the process.

Wait for the router bit to contact the Z-zero plate twice before removing the Z-zero plate or grounding clip.

After the bit makes second contact with the Z-zero plate, it will retract to a position of 1/2” above the deck. The Z-axis is now zeroed to the top of the MDF deck. This is the *Safe-Z Pullup* height which can be customized in the **[V]alues->[C]utter Values** menu.



Click “OK” to exit the program.

If using dust collection, re-attach the dust foot now.

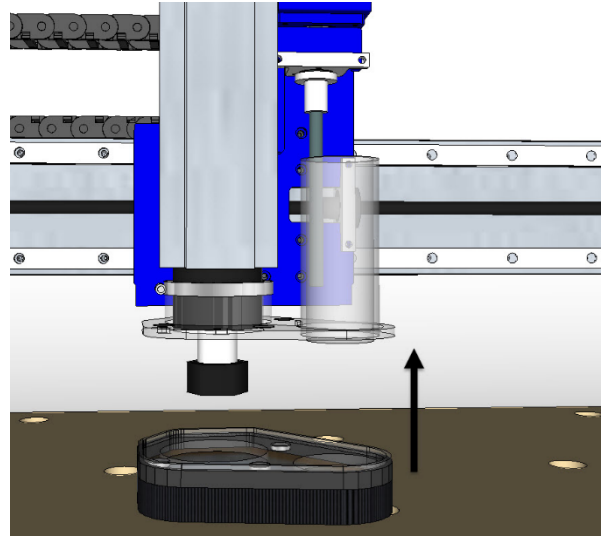

Move to Home Position – Keypad Shortcut



Click the button marked 0,0 shown in the picture to the left.

This will move the cutting head to the machines home position at the lower left (front) corner of the machine, as long as the tool has not lost position. Otherwise, the XY Zeroing routine will need to be run before the Home Position shortcut can be used effectively.

Spindle Warm-up Routine

Desktop tools equipped with a spindle require a warm-up cycle to bring the spindle bearings up to operating temperature. To do this, a routine is run at the normal operating RPM for 10 minutes while not under load. This should be done any time the spindle has been sitting idle for more than 3 hours.

Identify the spindle interlock switch, which is used to lock out power to the spindle for additional safety (picture to the right shows the key in the ENGAGED position).

Turn the spindle interlock switch ON by turning the key in a clockwise motion.



Locate the Variable-Frequency Drive (VFD) installed on the tool. This is used to control the RPMs of the spindle (shown in the picture to the left).

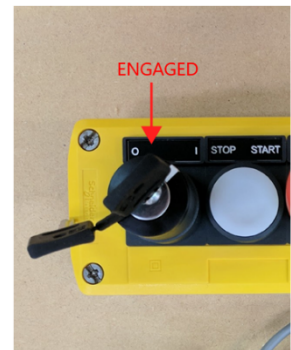

Adjust the knob so the display on the VFD reads approximately F200. This value represents the frequency the spindle is set to, F200 equals 12,000 RPM. Each 100 increment on the display is equivalent to 6,000 RPM for 60Hz power.

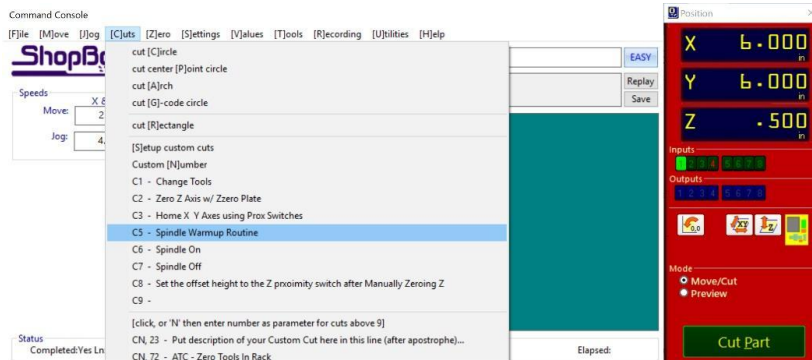

There are two methods to run this routine.

- 1) From the SB3 Command Console, select the **[C]uts->C[5] -Spindle Warmup routine**

2) Open the yellow KeyPad and click on the Output 1 button in the position window (shown in the picture to the right).

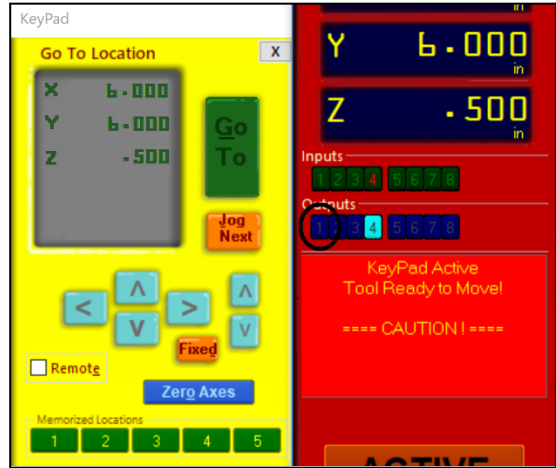

⚠ NOW STARTING ROUTER/SPINDLE ! ×

Start Router/Spindle with 'Start' Button, then click OK to Run PartFile. Cancel to terminate.

[If tool without Router/Spindle Control -- Turn on Router/Spindle Now.]



Then click “OK” on the prompt for the spindle to start. Allow it to run for 10 minutes to warmup.

After the warmup completes, click on the “X” to close the yellow KeyPad.

Desktop Spindle RPM Settings

Frequency to RPM chart for 60Hz (US, Canada, and Mexico. May also apply to other countries)

Display	Spindle RPM
300	15,000
266	13,300
233	11,650
200	10,000
166	8,300
133	6,650
100	5,000

Display	Spindle RPM
300	18,000
266	16,000
233	14,000
200	12,000
166	10,000
133	8,000
100	6,000

Frequency to RPM chart for 50Hz (Europe and most other regions)

Trim the Deck

Note: Do not proceed with this section until X-, Y-, and Z-axes have been zeroed and the spindle is warmed up!

Refer to the *Cutting the Rabbet* section of the “Desktop Series – Beginning Cuts and Operations” video for more information and a demonstration of this process. https://youtu.be/vscF113_tOE.

This step will cut a rabbet around the perimeter of the MDF deck to reveal the cutting area. Ensure the X-, Y- and Z-axes have been zeroed prior to running this routine.

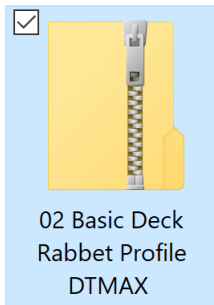
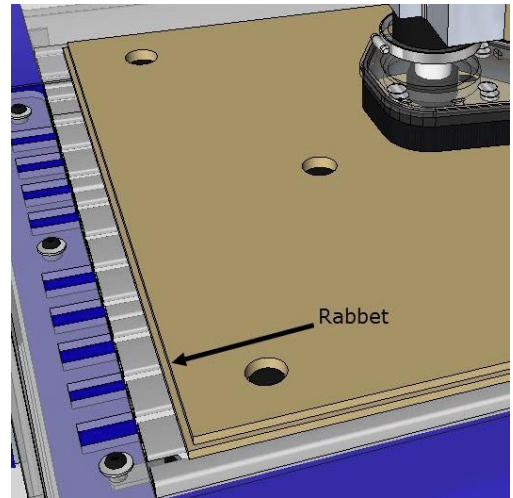

The rabbet file used in this step can be found on the USB drive that came with the tool. Transfer it from the drive to the control PC before running. If it is not present it can still be downloaded.

If the file needs to be downloaded, go to www.shopbottools.com, then click on the ShopBot Docs link at the center of the top of the main page. Then click on you tool (either Desktop or Desktop MAX).

Scroll to the bottom of the page under the “Files” heading and download the machine setup files (the “Work Area Cut File”) that corresponds with the tool type.



Download the zipped folder containing the rabbet .sbp file. Extract the file from the zipped folder and save it to the desktop

If the ShopBot 3 software is not currently open, double-click the ShopBot 3 shortcut icon to open the software.



Click the “Cut Part” button in the red position window.

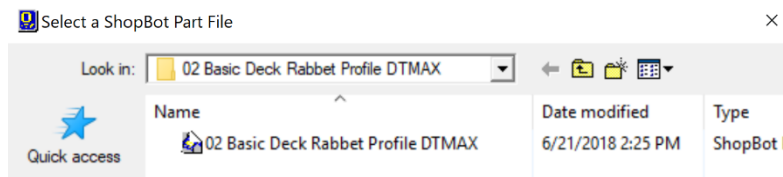

Navigate to the “Work Area Cut File,” double-click it or select it and click Open.



Click the "START" button to run the file.

Change bit? ×

Is tool number 2 in spindle?

Verify that there is a 1/4" upcut spiral cutter installed in the tool and click "Yes."

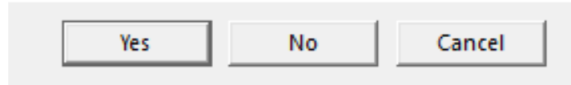

Note that the tool may be a number other than 2.

ZeroZ ×

If the Z-axis is zeroed to the top of the MDF deck, click "Yes."

Is Z axis zeroed?

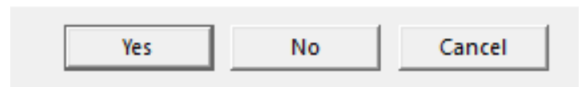

Turn on power to the cutting head now, if not already done.

If the machine is equipped with a router, its power switch will need to be engaged, and then the interlock switch will need to be turned clockwise (shown in the image to the right).



⚠ NOW STARTING ROUTER/SPINDLE ! ×

Start Router/Spindle with 'Start' Button, then click OK to Run PartFile. Cancel to terminate.

[If tool without Router/Spindle Control -- Turn on Router/Spindle Now.]



Click "OK" and the tool will take two passes around the perimeter of the deck, creating a rabbet that is approximately 1/8" wide by 3/8" deep.

Things to keep in mind:

The center section of the deck represents the useful cutting area of the Desktop, which is 24" x 36" on the Desktop MAX and 24" x 18" on the Desktop.

The lower left (front) corner of this center section represents the home position for the X- and Y-axes.

In many design programs, the ShopBot cut file created will have the tool automatically return to this position after it completes the cut.

Most X, Y measurements for designing and routine are based off this datum/home location.

Switch to ShopBot FULL

If not already in full mode, this section covers how to switch to ShopBot FULL from the ShopBotEASY interface which has limited functionality.



To do this from the ShopBotEASY position window, click on the blue help (?) button.

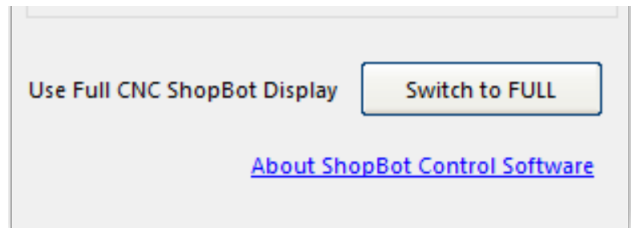

At the bottom of the window, click on the “Switch to FULL” button.

Click “OK” to continue to the FULL interface.

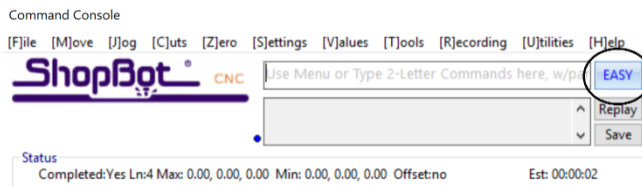

When the command console pops up, notice the “EASY” button is now available for switching back to ShopBotEASY.

Surfacing the Deck

Before continuing, for a visual demonstration and more information on creating and running the surfacing file in SB3 or VCarve Pro, refer to the *Cutting the Rabbet* section of the “Desktop Series – Creating Surfacing File” video - https://youtu.be/vscFI13_tOE.

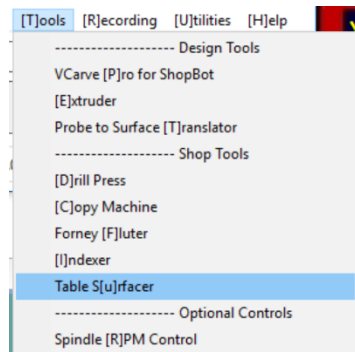

The basic deck is made of MDF which makes a good sacrificial surface, but the thickness can vary due to the manufacture of the material and changes in humidity. For most cutting operations this does not matter, but for critical depth cutting/pocket cutting or v-carving, the MDF should be surfaced first.

Use the “Table Surfacers” routine under “Tools” in the FULL ShopBot control. It can also be accessed by typing “TU”.

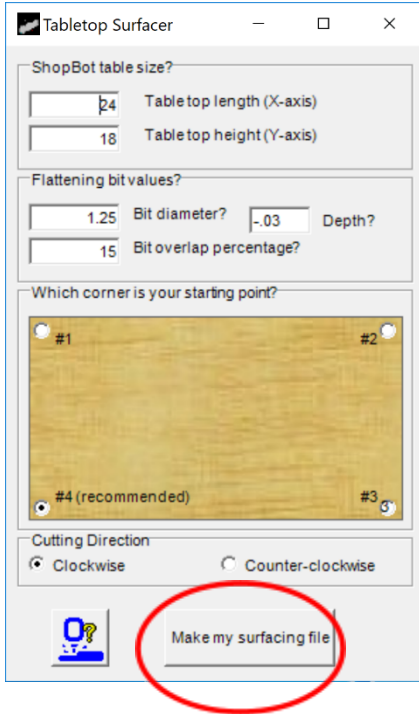

Choose a straight bit that is 1/2" or greater in diameter, then zero the bit to the top of the MDF. During the surfacing file, a lot of sawdust will be generated. Make sure the dust collection is hooked up and running before cutting if being used.

The default table size numbers may need to be changed to 36" x 24" on the MAX or 24" x 18" on the Desktop.

Set the depth to somewhere between -.01" and -.03" depending on how much variance in height the MDF has.

Laying a straight edge across the material is one of many methods that can help determine how much variance there is.

Change the bit diameter to match the chosen bit (1.25" in this example).

Then click the "Make my surfacing file" button.

Click "Yes" to proceed to the save window.

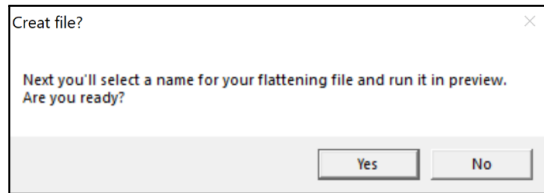

Save the file with a name that is easy to remember, in a location that is easy to find. Include the tool in the name for convenience later.

Click "Save" and a preview file will appear. Open and run the cut file. If an area of the deck is left unsurfaced, re-zero the Z-axis to the area that was missed and rerun the surfacing program.

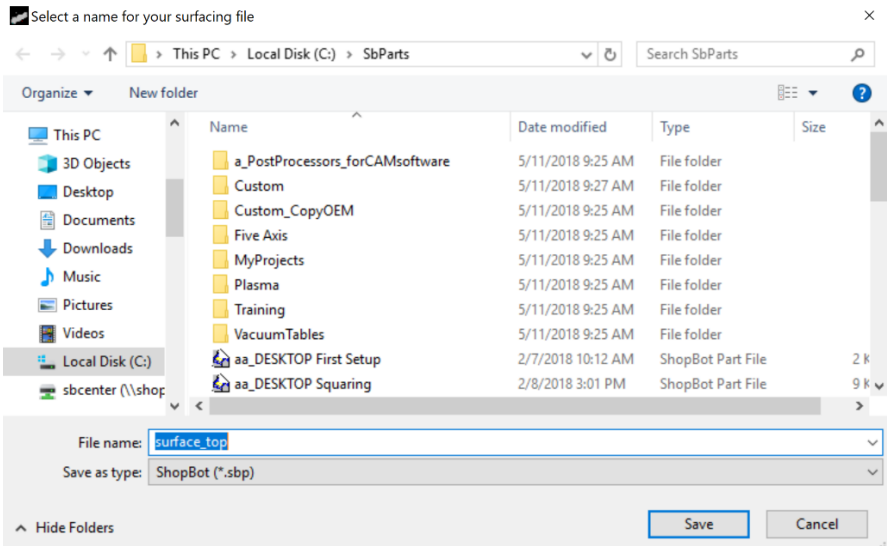

Repeat this program any time the deck gets worn from use. When the MDF deck gets thin and close to the bolts holding the deck to the machine, simply glue on a new piece of MDF – there is no need to remove the thin part that is still attached.

VCarve Pro

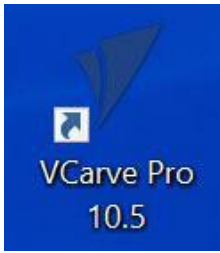

VCarve Pro is the designing/tool-pathing program that is included with the ShopBot and is used to create the part files for cutting.

When VCarve Pro is installed, it can be started through the shortcut icon shown to the left, or from the Start menu.

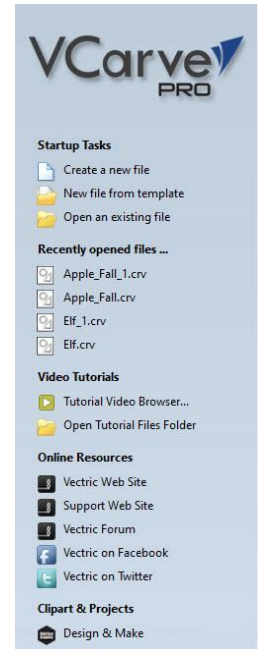

When first using VCarve Pro, it will be necessary to enter the registered username and license code provided with the machine purchase via email.

Tutorials are included with the installation and also can be found online. They are located in the “Tutorial Video Browser” section of VCarve Pro.

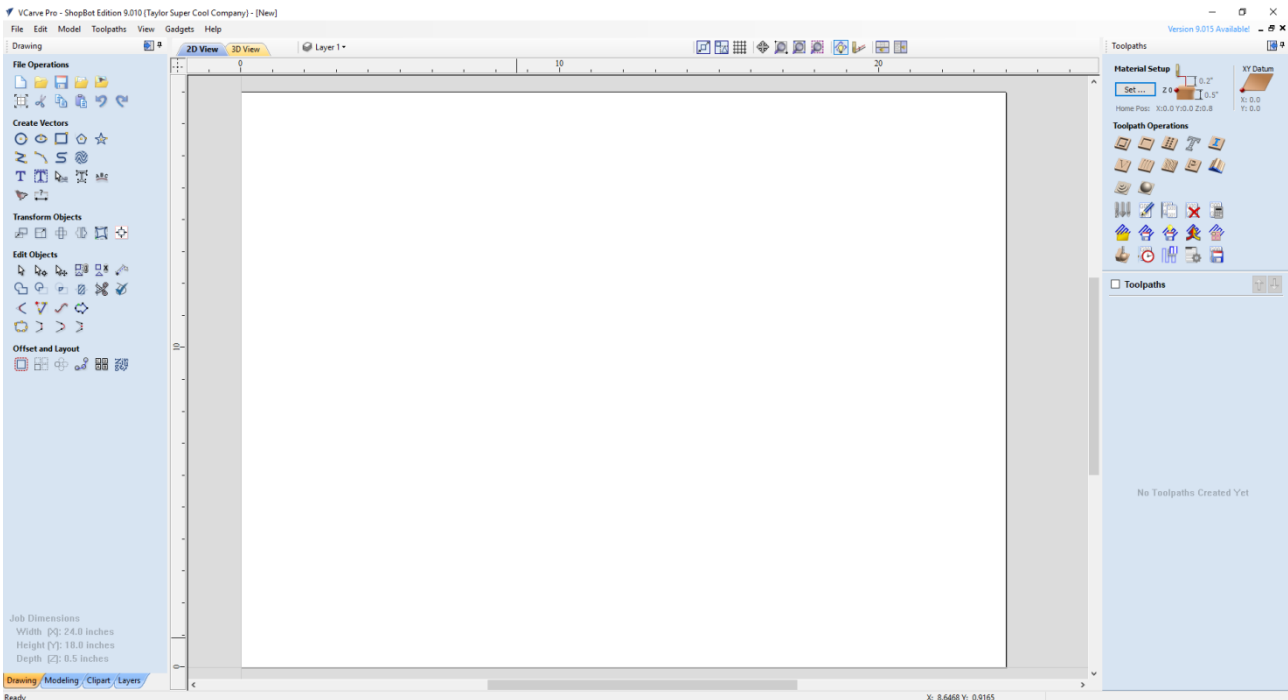

The graphic above is a basic overview of the program interface. There are many resources available about how to use this program. Some examples are tutorials, training at ShopBot, online training through ShopBot, help files provided in the program, and online support. Be sure to take advantage of these resources, many of them are listed in the resources section.

Maintenance

The ShopBot Desktop tools are very robust machines and do not often require maintenance. The table below covers general maintenance guidelines.

Item/Duration	Maintenance
Motor Screws	Wipe screws with a clean dry cloth. DO NOT USE any kind of lube or solvent-based cleaner on the Teflon coated screws. Doing so could cause the Teflon to flake off.
Rails	Wipe them with a clean, dry rag. Apply a light coat of machine oil. Wipe off excess oil as too much will attract dust.
After every 40 hours of use	Check for loose screws and parts.
On an as needed basis	Blow dust and debris out of hard to reach areas. Remove the blue panel covering the electronics enclosure and check for debris. This is especially true if cutting aluminum.
On an as needed basis (approximately every six months)	Wipe clean collets, collet nuts, and collet end of arbor. Apply a light coat of machine oil with an oil dampened rag (not soaked or dripping) to keep from rust.
NOTE: Damage or wear due to misuse or an accident will require additional attention depending on the problem.	

Transportation

The Desktop doesn't require any special considerations when moving or transporting the tool. The tool can weigh 150-190 lbs depending on the accessories and configuration of the tool. Ensure at least one additional person is present to help to carry or move the tool.

DO NOT quickly or forcefully move the gantry, as a charge can build in the motors and discharge through the control board. If possible, secure the gantry during transport.

After transporting, you will need to perform the *Tool Movement* and *Axis Zeroing* procedures described earlier in this document

Resources

ShopBot Tutorials & Videos

<https://support.shopbottools.com/training/tutorials>

ShopBot Training Classes

<https://support.shopbottools.com/training/basic>

CAD/CAM Software Packages

<http://www.shopbottools.com/mProducts/software.htm>

Tooling, Materials, and more...

www.shopbottools.com/mSupport/resourcelist.htm

ShopBot Forum

<http://www.talkshopbot.com/forum/forum.php>

Technical Support

<https://support.shopbottools.com/support/>